

TIDAL[®]
**Anterior Lumbar
Interbody Fusion System**

Fusion in the Lumbar Spine (L2-S1)

SURGICAL TECHNIQUE



restor3d

restor3d

Personalized Orthopaedics
Enabling Surgeons to Repair and
Reconstruct the Human Body

Backed by Science
Driven by Outcomes

r

THIS IS AN INTERACTIVE DOCUMENT

Contents

Product Overview	2
TIDAL® ALIF Cage Features	2
Sizing Options	2
TIDAL Technology™	3
Instrumentation	3
Trials	4
Indications & Contraindications	5
Surgical Technique	6
Graft Volumes	7
Explant Information	9
Ordering Information – Implants	9
TIDAL® ALIF Fusion Cages	9

IMPORTANT NOTE: restor3d, as the manufacturer of this device, does not practice medicine and does not recommend this or any other surgical technique for use on a specific patient. The surgeon who performs any procedure is responsible for determining and utilizing the appropriate techniques for such procedure for each individual patient. restor3d is not responsible for selection of the appropriate surgical technique to be utilized for an individual patient. Always refer to the package insert, product label and/or product instructions prior to using any restor3d product.

For further product information or to arrange a product demonstration, please contact your local restor3d representative or call Customer Service toll-free in the U.S. at (984) 888-0593 or email customerservice@restor3d.com. You can also visit www.restor3d.com.

Product Overview

The TIDAL® ALIF Cage is a sterile packed, 3D printed, Titanium Alloy interbody fusion device designed with an interconnected porous architecture to encourage bony ingrowth.² The cages are available in a variety of footprints and three lordotic offerings to accommodate the individual patient anatomy.

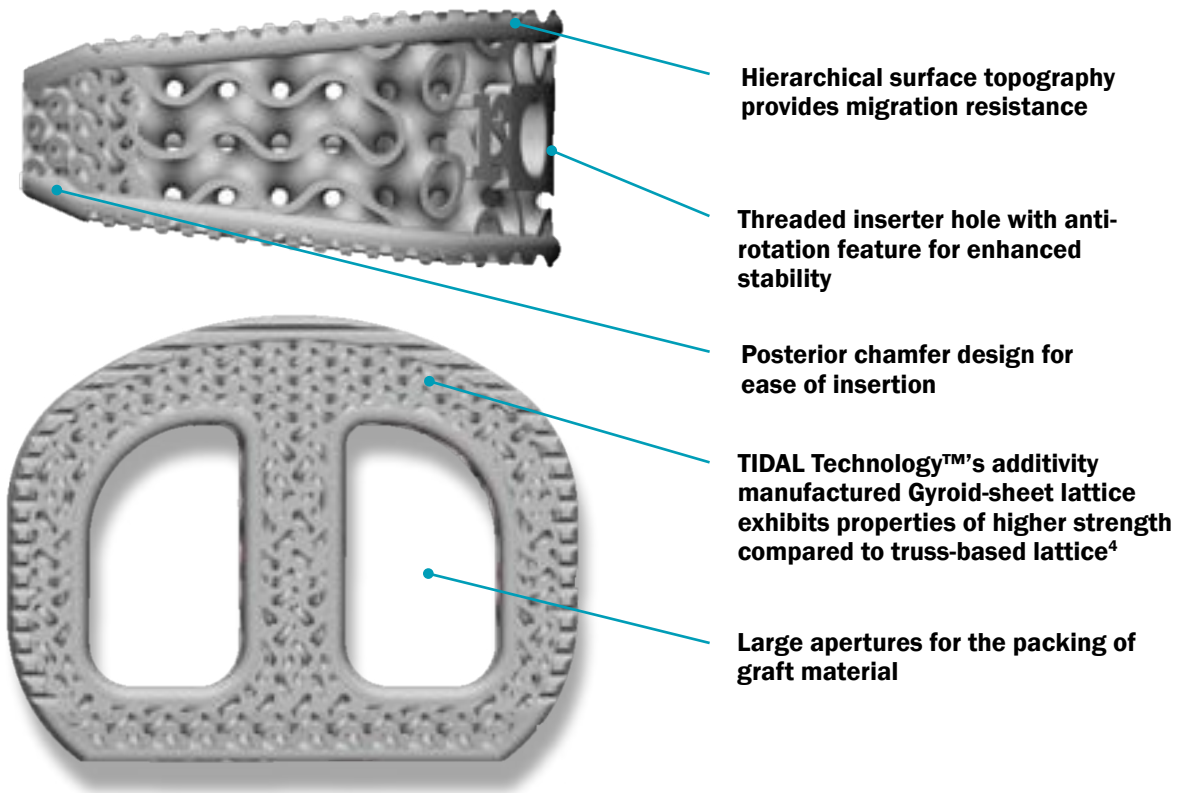

Sizing Options

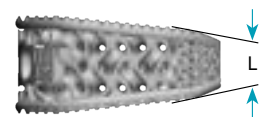
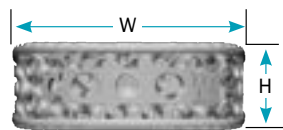
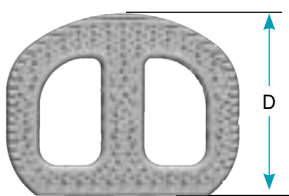

	Small (26 x 32mm)		
	12°	15°	18°
10mm	•		
12mm	•	•	•
14mm	•	•	•
16mm	•	•	•

	Medium (28 x 35mm)		
	12°	15°	18°
10mm	•		
12mm	•	•	•
14mm	•	•	•
16mm	•	•	•

	Large (30 x 38mm)		
	12°	15°	18°
10mm	•		
12mm	•	•	
14mm	•	•	•
16mm	•	•	•

Available footprints are denoted by •

TIDAL Technology™

Backed by scientific research and development

restor3d's TIDAL Technology™ is an optimized porous architecture designed for osseointegration. Derived from sinusoidal functions, TIDAL Technology™ guides bone growth through the fully interconnected structure with maximized surface area.

- 100% interconnectivity and up to 80% porosity¹
- Mesoscale pores support graft retention and bony ingrowth²
- Direct bony apposition to implant surface guided by surface topography and curvature demonstrated in preclinical model^{2,3}

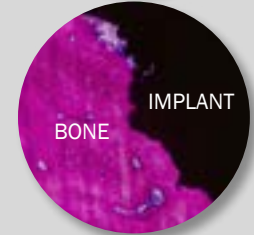

Instrumentation

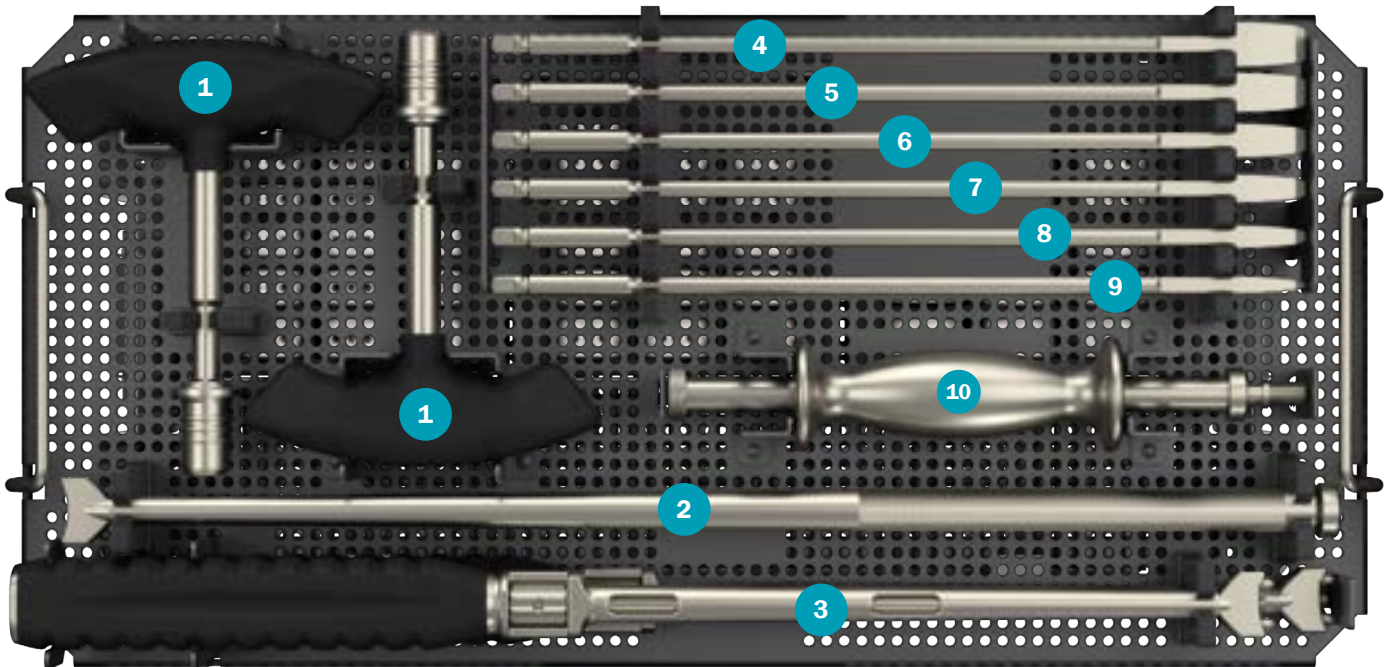

#	Description	Part No.	Qty
1	T-Handle	5113-A2001	2
2	Tamp	5113-A4001	1
3	Inserter	5113-A5001	2
4	Distractor 16mm, 8°	5113-A1006	1
5	Distractor 14mm, 8°	5113-A1005	1

#	Description	Part No.	Qty
6	Distractor 12mm, 8°	5113-A1004	1
7	Distractor 10mm, 8°	5113-A1003	1
8	Distractor 8mm, 8°	5113-A1002	1
9	Distractor 6mm, 8°	5113-A1001	1
10	Slap Hammer	5113-A3001	1

Trials

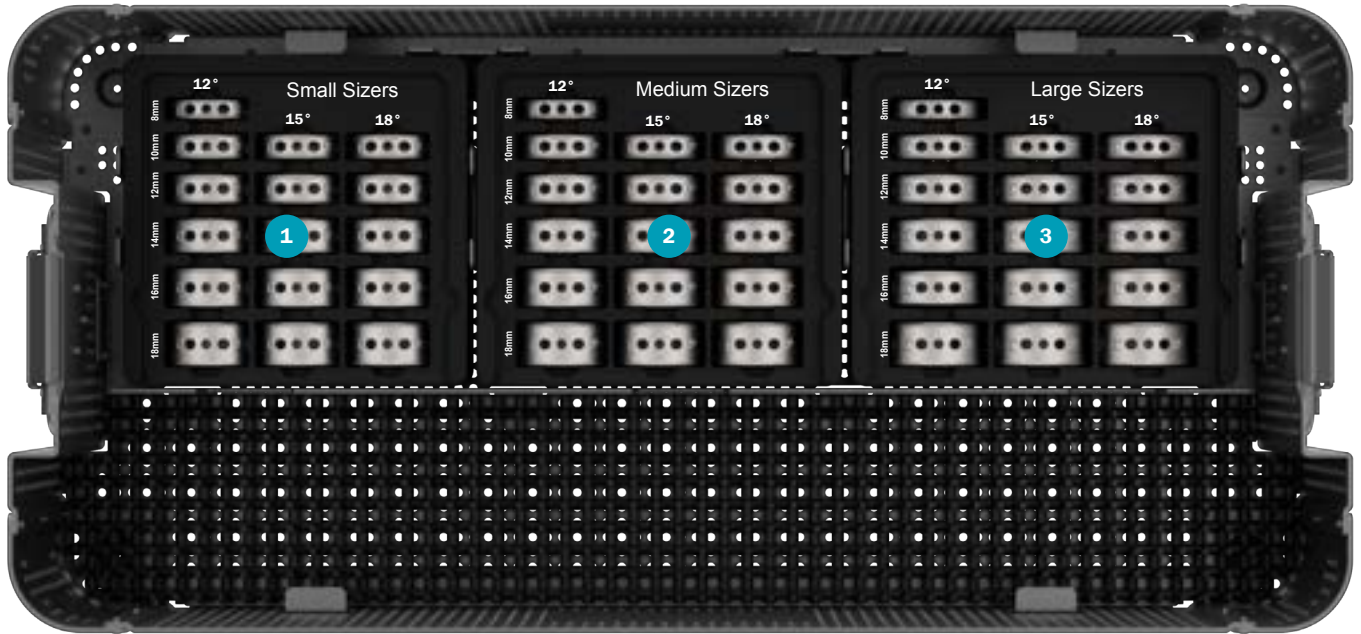

Caddy Lids are unique to each caddy and not pictured

#	Description	Part No.	Qty
1	ALIF Sizer Caddy - Small	5113-A0021	1
1	Small Trial, 8mm Ht, 12°	5113-S0812	1
1	Small Trial, 10mm Ht, 12°	5113-S1012	1
1	Small Trial, 10mm Ht, 15°	5113-S1015	1
1	Small Trial, 10mm Ht, 18°	5113-S1018	1
1	Small Trial, 12mm Ht, 12°	5113-S1212	1
1	Small Trial, 12mm Ht, 15°	5113-S1215	1
1	Small Trial, 12mm Ht, 18°	5113-S1218	1
1	Small Trial, 14mm Ht, 12°	5113-S1412	1
1	Small Trial, 14mm Ht, 15°	5113-S1415	1
1	Small Trial, 14mm Ht, 18°	5113-S1418	1
1	Small Trial, 16mm Ht, 12°	5113-S1612	1
1	Small Trial, 16mm Ht, 15°	5113-S1615	1
1	Small Trial, 16mm Ht, 18°	5113-S1618	1
1	Small Trial, 18mm Ht, 12°	5113-S1812	1
1	Small Trial, 18mm Ht, 15°	5113-S1815	1
1	Small Trial, 18mm Ht, 18°	5113-S1818	1

#	Description	Part No.	Qty
2	ALIF Sizer Caddy - Medium	5113-A0022	1
2	Med. Trial, 8mm Ht, 12°	5113-M0812	1
2	Med. Trial, 10mm Ht, 12°	5113-M1012	1
2	Med. Trial, 10mm Ht, 15°	5113-M1015	1
2	Med. Trial, 10mm Ht, 18°	5113-M1018	1
2	Med. Trial, 12mm Ht, 12°	5113-M1212	1
2	Med. Trial, 12mm Ht, 15°	5113-M1215	1
2	Med. Trial, 12mm Ht, 18°	5113-M1218	1
2	Med. Trial, 14mm Ht, 12°	5113-M1412	1
2	Med. Trial, 14mm Ht, 15°	5113-M1415	1
2	Med. Trial, 14mm Ht, 18°	5113-M1418	1
2	Med. Trial, 16mm Ht, 12°	5113-M1612	1
2	Med. Trial, 16mm Ht, 15°	5113-M1615	1
2	Med. Trial, 16mm Ht, 18°	5113-M1618	1
2	Med. Trial, 18mm Ht, 12°	5113-M1812	1
2	Med. Trial, 18mm Ht, 15°	5113-M1815	1
2	Med. Trial, 18mm Ht, 18°	5113-M1818	1

#	Description	Part No.	Qty
3	ALIF Sizer Caddy - Large	5113-A0023	1
3	Large Trial, 8mm Ht, 12°	5113-L0812	1
3	Large Trial, 10mm Ht, 12°	5113-L1012	1
3	Large Trial, 10mm Ht, 15°	5113-L1015	1
3	Large Trial, 10mm Ht, 18°	5113-L1018	1
3	Large Trial, 12mm Ht, 12°	5113-L1212	1
3	Large Trial, 12mm Ht, 15°	5113-L1215	1
3	Large Trial, 12mm Ht, 18°	5113-L1218	1
3	Large Trial, 14mm Ht, 12°	5113-L1412	1
3	Large Trial, 14mm Ht, 15°	5113-L1415	1
3	Large Trial, 14mm Ht, 18°	5113-L1418	1
3	Large Trial, 16mm Ht, 12°	5113-L1612	1
3	Large Trial, 16mm Ht, 15°	5113-L1615	1
3	Large Trial, 16mm Ht, 18°	5113-L1618	1
3	Large Trial, 18mm Ht, 12°	5113-L1812	1
3	Large Trial, 18mm Ht, 15°	5113-L1815	1
3	Large Trial, 18mm Ht, 18°	5113-L1818	1

Indications

The restor3d lumbar cages are intended to be used as an intervertebral body fusion device with bone graft for use in lumbar spine. They are indicated for use in skeletally mature patients with degenerative disc disease (defined as discogenic back pain with degeneration of the disc confirmed by patient history and radiographic studies) at one or two contiguous levels from L2-S1. DDD patients may also have up to grade 1 spondylolisthesis or retrolisthesis at the involved level(s). Implants are used to facilitate fusion in the lumbar spine using autograft and/or allogeneic bone graft comprised of cancellous and/or corticocancellous bone graft. Patients must have undergone a regimen of at least six (6) months of non-operative treatment prior to being treated with the device. The device is intended to be used with supplemental fixation systems that have been cleared for use in the lumbar spine.

Contraindications

- Surgical procedures other than those listed in the indications for use.
- Patients with an active local or systemic infection.
- Conditions which tend to retard healing such as blood supply limitations or previous infections.
- Skeletally immature patients where the implanted device would cross open epiphyseal plates.
- Grossly distorted anatomy due to congenital abnormalities.
- Inadequate tissue coverage over surgical site.
- Insufficient quality or quantity of bone, comminuted bone surfaces or pathologic conditions such as cystic change or severe osteopenia that would impair the ability of the restor3d Lumbar Interbody Fusion Cage to securely fixate to the bone.
- Inadequate neuromuscular status (e.g. paralysis, inadequate muscle strength).
- Patients with conditions such as mental illness, senility or alcoholism that tend to restrict his or her willingness to follow postoperative instructions during the healing process.
- Patients with foreign body sensitivity, suspected or documented material allergy or intolerance. Where material sensitivity is suspected, appropriate tests should be conducted and sensitivity ruled out prior to implantation.

Surgical Technique

- 1. Prepare, position, and drape the patient per standard procedure.**
- 2. Expose the affected levels via a standard anterior approach incision and tissue dissection.**
- 3. Perform any necessary bone and tissue removal.**
- 4. Remove disc material and prepare endplates using the appropriate instruments. Use a combination of curettes, rasps, osteotomes, disc shavers, and/or box chisels to remove the disc material and cartilage from the vertebral endplates.**

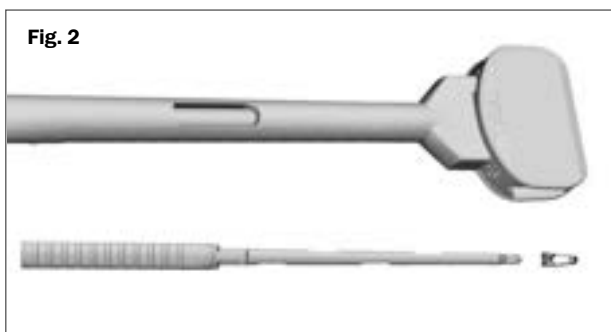

- 5. Prepare the intervertebral disc space per surgeon preference.**

Take care to remove the anterior longitudinal ligament to ensure proper implant fit.

- 6. Assemble the inserter to the Trial.**

The inserter is attached to the trial by aligning the anti-rotation feature and the threaded central rod into the trial. To secure the trial, turn the knob on the inserter in a clockwise direction with two fingers until you feel tightness. (Figs. 1 and 2).

- 7. After trial is locked on the inserter, insert it into the disc space to determine correct implant size needed.**

When selecting the a trial, consider the various sizing parameter including footprint, height, and lordosis. Start with the small trial height and footprint. Use progressively increasing heights until the desired height distraction is achieved. Note, trials are line to line.

Radiographically confirm the trials height, lordosis, and footprint is satisfactory for the anatomical condition (Fig 3).

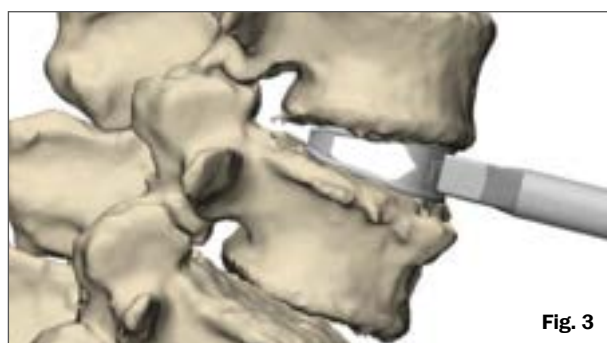

Fig. 3

8. Prepare the implant, including packing with bone graft material, if desired.

Pack the interior of the cage with bone graft material. Note that the large, central graft window, in addition to the porous lattice, can be packed with graft material (Fig. 4).

PRECAUTION: It is important to fill the implant graft volume fully to ensure optimal contact with the vertebral endplates. Refer to Graft Volume Tables

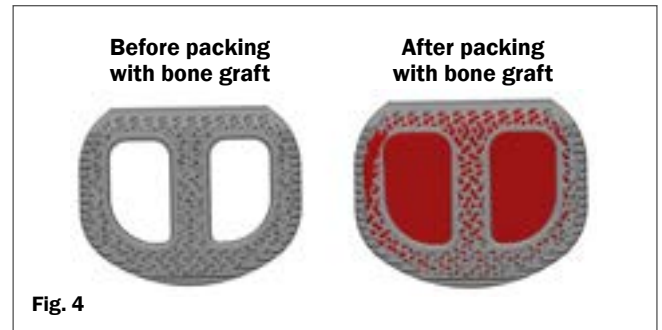

Fig. 4

Small (26x32mm)		Medium (28x35mm)		Large (30x38mm)	
PRODUCT CODE	GRAFT VOLUME*	PRODUCT CODE	GRAFT VOLUME*	PRODUCT CODE	GRAFT VOLUME*
1113-S1012	2.70cc	1113-M1012	3.32cc	1113-L1012	4.02cc
1113-S1212	3.37cc	1113-M1212	4.17cc	1113-L1212	5.07cc
1113-S1215	3.19cc	1113-M1215	3.92cc	1113-L1215	4.72cc
1113-S1218	3.08cc	1113-M1218	3.76cc		
1113-S1412	4.04cc	1113-M1412	5.02cc	1113-L1412	6.12cc
1113-S1415	3.87cc	1113-M1415	4.77cc	1113-L1415	5.77cc
1113-S1418	3.37cc	1113-M1418	4.61cc	1113-L1418	5.55cc
1113-S1612	4.71cc	1113-M1612	5.87cc	1113-L1612	7.17cc
1113-S1615	4.54cc	1113-M1615	5.62cc	1113-L1615	6.82cc
1113-S1618	4.42cc	1113-M1618	5.45cc	1113-L1618	6.60cc

*Graft volumes includes packing of both the implant aperture and surrounding lattice structure

9. Attach selected implant to the inserter.

Load implant onto the inserter by aligning the anti-rotation features and turning the inserter knob to thread the rod into the implant (Figs. 5 and 6).

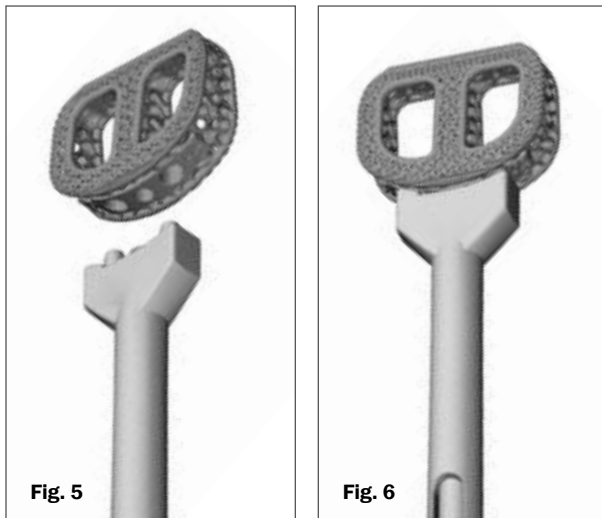

10. Orient the implant and inserter in the correct alignment and carefully insert the implant into the distracted segment.

Carefully insert the implant into the distracted segment. If necessary, use light impaction to advance the implant into the intervertebral disc space (Fig. 7).

PRECAUTION: When inserting the implant, take care to avoid using excessive impaction force to prevent damage to the implant or surrounding tissue.

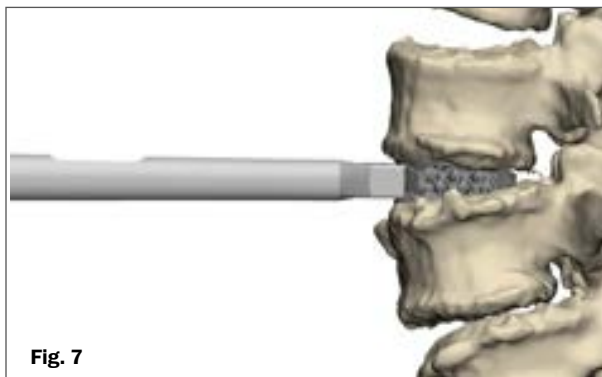

11. Radiographically verify implant position

12. Remove the inserter handle from the disc space.

Turn the knob in a counterclockwise direction to release the implant from the implant inserter (Figs. 8 and 9).

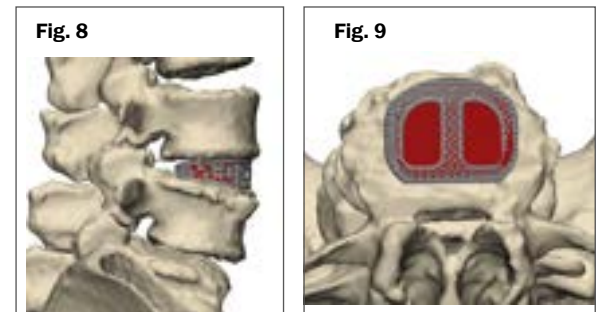

13. If necessary, lightly tamp the implant with the reusable tamp to obtain final position (Fig. 10)

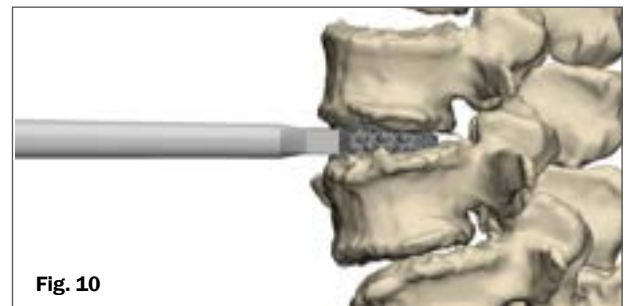

14. Supplemental Fixation

Use of supplemental fixation is required with the restor3d Tidal ALIF Interbody Fusion System.

Explant Information

If this implant needs to be removed due to a revision or device failure the surgeon can do so by attaching the implant inserter into the threads of the implant until tightened. The slap hammer provided within the ALIF System Instrumentation tray can be threaded onto the back of the inserter (Fig. 11) and the implant extracted (Fig. 12). If the implant cannot be easily removed, a Cobb elevator or osteotome may be used to loosen the bone to implant interface, if needed.

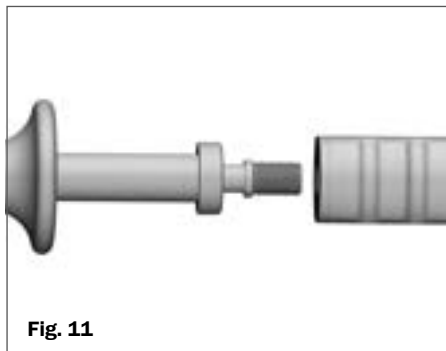

Fig. 11



Fig. 12

Ordering Information

Implants

TIDAL® ALIF Fusion Cages (Small)

IMPLANT	PRODUCT CODE	FOOTPRINT	DEPTH	WIDTH	ANTERIOR HEIGHT	LORDOSIS	POSTERIOR HEIGHT
	1113-S1012	Small	26mm	32mm	10mm	12°	5.74
	1113-S1212				12mm	12°	7.74
	1113-S1215					15°	6.66
	1113-S1218					18°	5.58
	1113-S1412				14mm	12°	9.74
	1113-S1415					15°	8.66
	1113-S1418					18°	7.58
	1113-S1612				16mm	12°	11.74
	1113-S1615					15°	10.66
	1113-S1618					18°	9.58

Ordering Information

Implants

TIDAL® ALIF Fusion Cages (Medium)

IMPLANT	PRODUCT CODE	FOOTPRINT	DEPTH	WIDTH	ANTERIOR HEIGHT	LORDOSIS	POSTERIOR HEIGHT
	1113-M1012	Medium	28mm	35mm	10mm	12°	5.32
	1113-M1212				12mm	12°	7.32
	1113-M1215					15°	6.14
	1113-M1218					18°	4.95
	1113-M1412					14mm	12°
	1113-M1415				15°		8.14
	1113-M1418				18°		6.95
	1113-M1612				16mm	12°	11.32
	1113-M1615					15°	10.14
	1113-M1618					18°	8.95

TIDAL® ALIF Fusion Cages (Large)

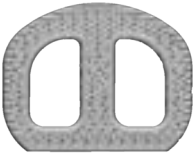
IMPLANT	PRODUCT CODE	FOOTPRINT	DEPTH	WIDTH	ANTERIOR HEIGHT	LORDOSIS	POSTERIOR HEIGHT
	1113-L1012	Large	30mm	38mm	10mm	12°	4.90
	1113-L1212				12mm	12°	6.90
	1113-L1215					15°	5.61
	1113-L1412				14mm	12°	8.90
	1113-L1415					15°	7.61
	1113-L1418					18°	6.31
	1113-L1612				16mm	12°	10.90
	1113-L1615					15°	9.61
	1113-L1618					18°	8.31



restor3d

Durham, NC
Phone: (984) 888-0593
Email: customerservice@restor3d.com
www.restor3d.com

CAUTION: Federal (USA) law restricts this device to sale by or on the order of a physician.
© 2023 restor3d, Inc. Marks noted with ® or TM are trademarks of restor3d, Inc. Other marks mentioned herein may be trademarks of restor3d, Inc. or of their respective owners. Patents: www.restor3d.com/patents. All Rights Reserved.
Printed in the USA. LBL-70053 Rev 02 DEC2023

1. Kelly, et al. *Acta Biomaterialia* (2019) 94, 601-626.
2. Kelly, et al. *Journal of the Mechanical Behavior of Biomedical Materials* (2021) 116, 104380.
3. Kelly, et al. *Biomaterials* (2021) 279, 121206.
4. Kelly, C.N., Kahra, C., Maier, H. J., Gall, K. (2021). Processing, structure, and titanium scaffolds with gyroid-sheet architecture. *Additive Manufacturing*. 21(2021)101916. DOI: 10.1016/j.addma.2021.101916.